

Measure square corp
 Measure square corp
 221 E Walnut St., suite 110
 Pasadena, CA 91101











Customer	Job Site

Project Summary							
Tab	#Rooms	#Stairs	Floor Area	Wall Area	Base Peri	#Doors	#Windows
Security Plan	12	0	2,114.49 SF	5,558.33 SF	666'2"	6(18'0")	0

Room List						
Name	Floor Area	Wall Area	Base Peri	#Doors	#Windows	
Security Plan						
Rm1	62.70 SF	257.35 SF	32'2"	0	0	
Rm2	422.39 SF	1,120.45 SF	111'5"	1(3'0")	0	
Rm3	116.32 SF	383.62 SF	47'11"	0	0	
Rm4	138.01 SF	355.73 SF	44'6"	1(3'0")	0	
Rm5	82.06 SF	279.70 SF	35'0"	1(3'0")	0	
Rm6	61.61 SF	225.71 SF	28'3"	1(3'0")	0	
Rm7	54.40 SF	236.20 SF	29'6"	0	0	
Rm8	80.44 SF	309.09 SF	38'8"	0	0	
Rm9	889.39 SF	1,517.69 SF	189'9"	2(6'0")	0	
Rm10	40.94 SF	208.71 SF	26'1"	0	0	
Rm11	52.16 SF	231.52 SF	28'11"	0	0	
Rm13	114.08 SF	432.56 SF	54'1"	0	0	

Item Description	Usage	Linear Length	Net Area	Base Peri	Seam Length	Waste*
<input type="checkbox"/> Card Reader EA	5.0		5.0			0.0%
<input type="checkbox"/> CCTV Monitor EA	3.0		3.0			0.0%
<input checked="" type="checkbox"/> Device Install EA	12.0 (12*1EA/Hour)		12.0			0.0%
<input type="checkbox"/> Indoor Camera 1 EA	5.0		5.0			0.0%
<input type="checkbox"/> Indoor Dome 360 Camera EA	7.0		7.0			0.0%
<input type="checkbox"/> Motion Sensor EA	16.0		16.0			0.0%
<input type="checkbox"/> Outdoor Camera EA	2.0		2.0			0.0%

* For roll products, the waste is waste ratio; for others, the waste is waste addon.

-  Card Reader EA
-  CCTV Monitor EA
-  Control Pannel EA
-  Control Sensor EA
-  Control Switch EA
-  Device Install EA
-  Indoor Camera 1 EA
-  Indoor Dome 360 Camera EA
-  Motion Sensor EA
-  Outdoor Camera EA



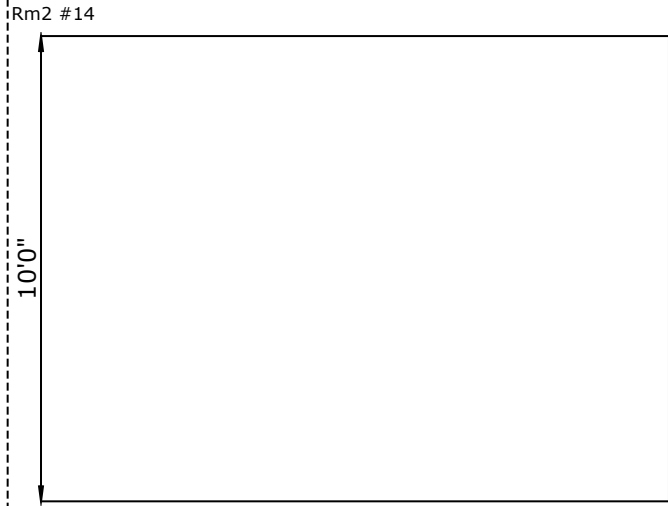
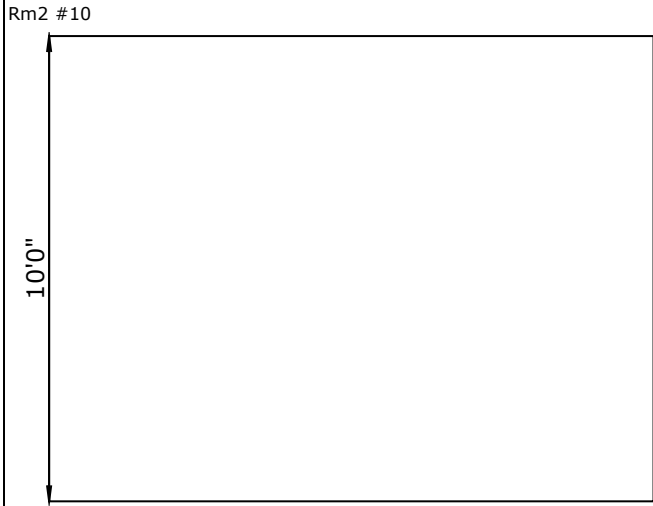
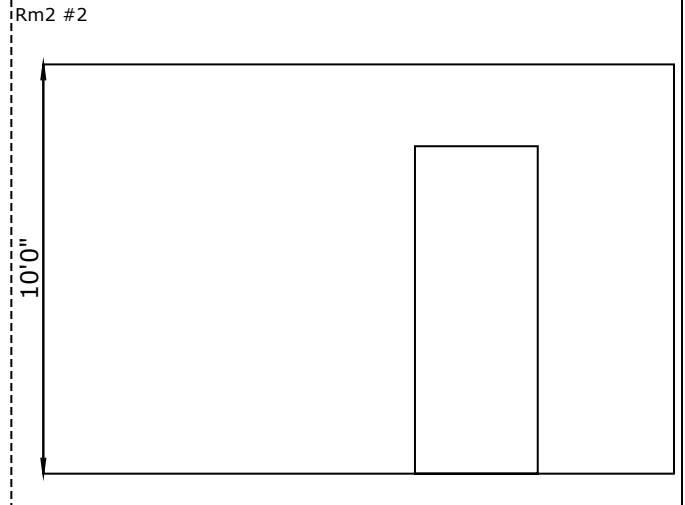
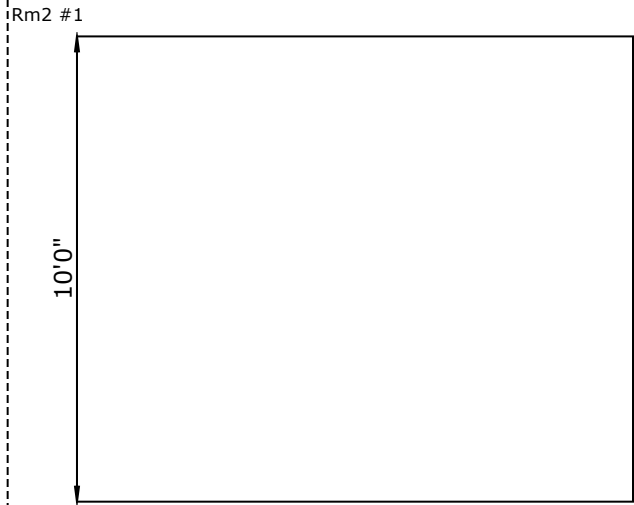
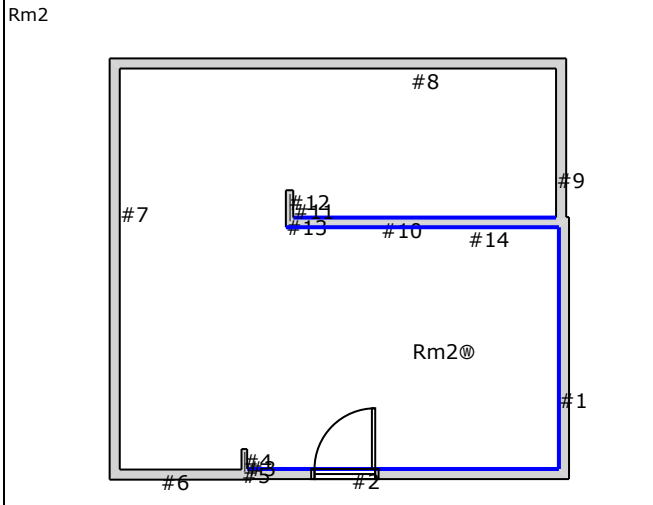

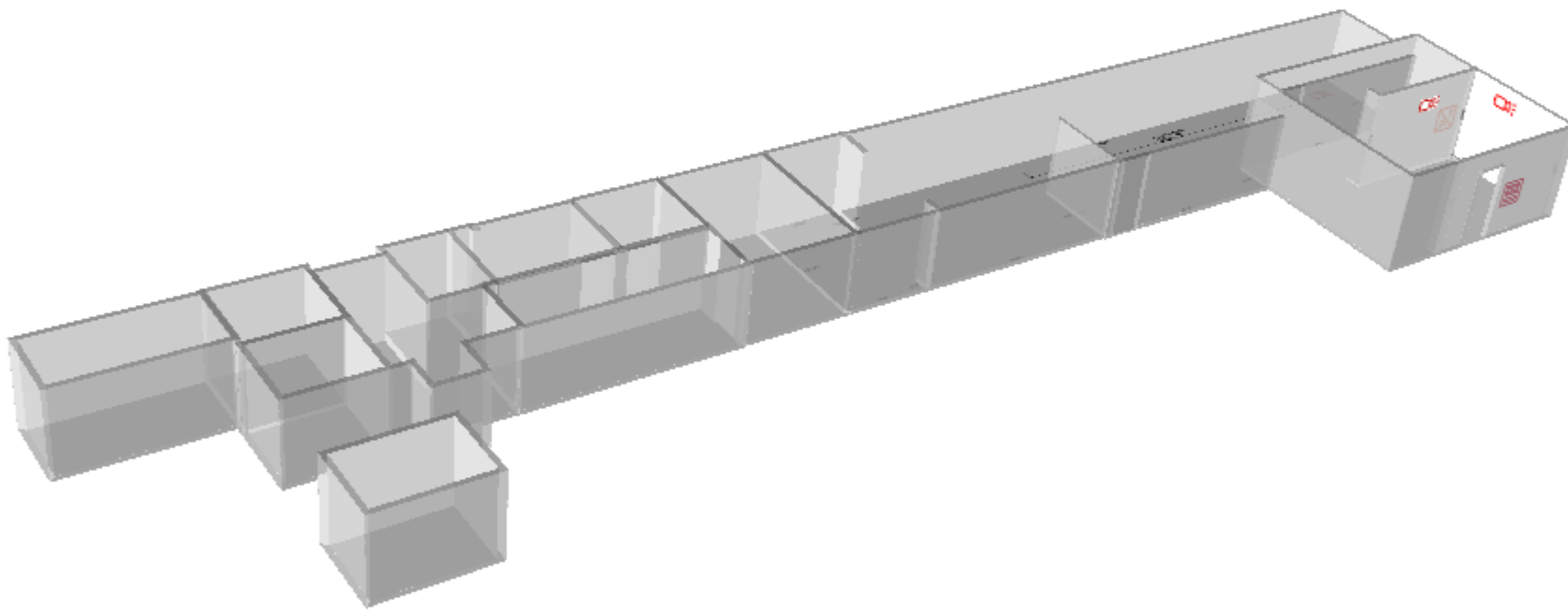



Measure square corp

Measure square corp
221 E Walnut St., suite 110
Pasadena, CA 91101

Proposal

5/5

BILL TO **SHIP TO**

SKU#/ITEM NO.	DESCRIPTION	QTY UNIT
Card Reader		4 EA
CCTV Monitor		3 EA
Control Pannel		1 EA
Control Sensor		1 EA
Control Switch		1 EA
Device Install		12 Hour
Indoor Camera 1		3 EA
Indoor Dome 360 Camera		7 EA
Motion Sensor		15 EA
Outdoor Camera		2 EA

Material	\$2,268.00
Labor	\$660.00
Tax Sales 10.0%	\$292.80
Total	\$3,220.80

CUSTOMER ACCEPTANCE AND APPROVAL

Print Name **Signature**

Date 9/8/2021 6:54 PM